

DESIGNED BY AITOR GARCÍA DE VICUÑA

**FAMO!**  
WORKING  
TOGETHER

# Mahia







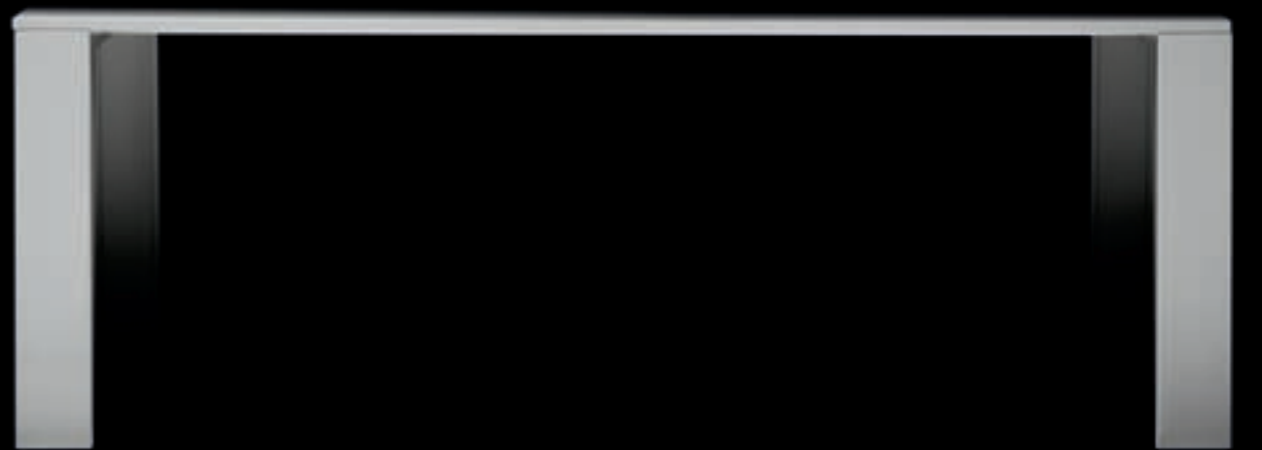



## Mahia System

Inspirado na superfície de trabalho simples e desenhado por *Aitor García de Vicuña*, Mahia assume como ponto de referência a mesa, da qual, ao adicionar distintas operações permite a criação do posto individual, bem como um universo institucional. Forma e função reunidas num só produto de proporções singulares que a fazem ser identificável.

Inspirado en la superficie de trabajo básica y diseñado por *Aitor García de Vicuña*, Mahia toma la mesa como punto de referencia, al que añade diversas intervenciones que permiten crear desde puestos individuales hasta un universo de empresa. Funcionalidad y estética unidas en un solo producto de proporciones singulares que lo hacen decididamente reconocible.

Trouvant son inspiration dans la surface de travail de base et créé par *Aitor García de Vicuña*, Mahia prend la table comme point de référence, auquel il ajoute diverses interventions qui permettent de créer des solutions allant de postes individuels à un univers d'entreprise. Fonctionnalité et esthétique réunies en un seul produit aux proportions singulières qui le rendent reconnaissable sans coup férir.

Inspired by the basic work surface and designed by *Aitor García de Vicuña*, Mahia starts out with a table and then uses it to create a range from individual workstations to a business universe. Functionality and aesthetics come together in a single product of unusual proportions that make them immediately recognisable.



Trabalho individual / Trabajo individual  
Travail individuel / Individual work

Um sistema que aborda as necessidades concretas do utilizador, tanto tecnológicas como de organização e privacidade, permitindo criar composições diversas devido à modularidade com que foi criado.

Un sistema que aborda las necesidades concretas del usuario, tanto tecnológicas como de organización y privacidad, permitiendo crear composiciones diversas gracias a la modularidad con la que ha sido creado.

Un système qui prend en compte les besoins concrets de l'utilisateur, qu'ils soient technologiques ou d'organisation et de privacité, en permettant de créer des compositions diverses grâce à la modularité avec laquelle il a été créé.

A system that tackles the specific needs of users, from the point of view of technology, organisation and privacy, which allows different compositions to be created thanks to the modularity with which it has been designed.

# Individual

# Team

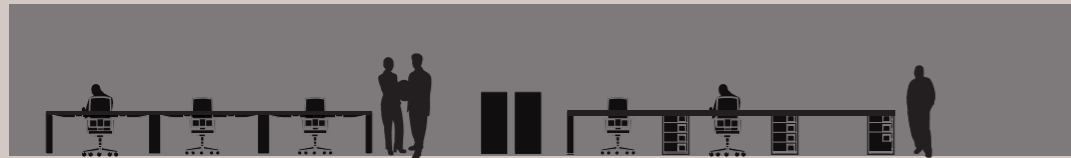

Trabalho em equipa / Trabajo en equipo  
Travail en équipe / Team work

Um sistema coerente com a nova maneira de entender os postos de trabalho que fomentam a comunicação entre os trabalhadores, optimizando, melhorando e organizando o espaço graças à versatilidade do sistema.

Un sistema coerente con la nueva manera de entender los puestos de trabajo que fomenten la comunicación entre los trabajadores, optimizando, mejorando y organizando el espacio gracias a la versatilidad del sistema.

Un système cohérent avec la nouvelle manière d'entendre les postes de travail qui encouragent la communication entre le personnel, optimisant, améliorant et organisant l'espace grâce à la versatilité du système.

A system that is coherent with the new way of seeing workstations that foster communication between the workers, by optimising, improving and organising the space thanks to the versatility of the system.

# Organized



Trabalho organizado / Trabajo organizado  
Travail organisé / Organised work

Zonas de armazenamento, que ligam os diferentes departamentos entre si, personalizando ao máximo cada espaço graças aos acessórios, à variedade de cores, materiais e possibilidades de portas.

Zonas de almacenamiento, que conectan los diferentes departamentos entre sí, personalizando al máximo cada espacio gracias a los accesorios, la variedad de colores, materiales y posibilidades de puertas.

Zones de rangement, qui connectent les différents départements entre eux, personnalisant au maximum chaque espace grâce aux accessoires, à la variété des coloris, des matériaux et des possibilités de portes.

Storage zones, which interconnect the different departments, where each space can be highly personalised thanks to the accessories, the variety of colours, materials and ranges of doors.

# Company



Universo de empresa / Universo de empresa  
Univers d'entreprise / Company universe

Soluções globais para um mundo criado por e para pessoas que convivem, trabalham e se interrelacionam.

Soluciones globales para un mundo creado por y para personas que conviven, trabajan y se interrelacionan.

Des solutions globales pour un monde créé par et pour des personnes qui cohabitent, travaillent et sont en interrelation.

Global solutions for a world created by and for people who coexist, work and interrelate.

**Operative** 012

**Bench** 024

**Technical wall** 040

**Meeting** 054

**Management** 066

**Reception** 074

**Cupboards** 084

**Technical data** 094

# Operative

## Operativo

A versão operativa de Mahia é um sistema com um alto desenvolvimento modular, que permite solucionar tanto gabinetes pequenos e individuais como escritórios e instalações de maior envergadura. Desta maneira, o espaço pode organizar-se de acordo com as necessidades de cada usuário, utilizando uma única mesa simples ou jogando com todas as suas possibilidades de composição. Podem criar-se, assim, postos simples, frente a frente, corredos, postos com alonga, ou ilhas de trabalho, entre muitas outras.

## Opérationnel

La version opérationnelle de Mahia est un système offrant un haut développement modulaire, qui permet d'offrir des solutions pour des studios petits et individuels que pour des bureaux et installations de plus grande envergure. De la sorte, l'espace peut s'organiser conformément aux besoins de chacun en utilisant une seule table simple ou en jouant de toutes ses possibilités de composition. On peut créer de cette manière des postes simples, en vis-à-vis, longs, bureaux avec retour ou des îlots de travail, entre tant d'autres solutions.

## Operativo

La versión operativa de Mahia es un sistema con un alto desarrollo modular, que permite solucionar tanto estudios pequeños e individuales como oficinas e instalaciones de mayor envergadura. De esta manera, el espacio puede organizarse de acuerdo a las necesidades de cada usuario, utilizando una única mesa sencilla o jugando con todas sus posibilidades compositivas. Pueden crearse, así, puestos simples, enfrentados, corredos, puestos con ala o islas de trabajo, entre muchas otras.

## Operative

The Mahia operative version is a system with a high modular development, that can provide solutions whether they are for small, individual studios or larger offices and installations. Thus, the space can be organised in accordance with the needs of each user, whether he is looking for a single simple table or wants to use the whole range of design possibilities. Single, opposite, side-by-side stations can be created, along workstations with extension, to name just a few.









Na imagem, um posto corrido e um simples, personalizados com blocos de gavetas e armário de portas de correr.

Sur l'image, un poste de travail en longueur et un poste simple, personnalisés au moyen de caissons et d'armoire à portes coulissantes.

En la imagen, un puesto corrido y uno simple, personalizados con bloques de cajones y armario de puertas correderas.

The photo shows a side-by-side and a single station, customised by blocks of drawers and a cupboard with sliding doors.

## Mahia System.

A estrutura das mesas Mahia atinge diferentes dimensões em função da solução desejada, podendo criar secretárias individuais, postos duplos, postos com alongas, etc. Mahia conta ainda com blocos de diversas dimensões, mecanismos e configurações.

Le structure des tables Mahia atteint différentes longueurs en fonction de la solution recherchée, pour créer tables individuelles, postes doubles, postes avec ailes, etc. De plus, Mahia dispose de caissons offrant différentes profondeurs, mécanismes et configurations.

La estructura de las mesas Mahia alcanza diferentes longitudes en función de la solución deseada, pudiendo crear mesas individuales, puestos dobles, puestos con alas, etc. Además, Mahia cuenta con bloques de diversas profundidades, mecanismos y configuraciones.

The structure of the Mahia tables comes in different lengths according to the desired solutions, which means that individual tables, double stations, stations with wings, etc. can be created. Mahia also comes with blocks of different depths, mechanisms and configurations.



A modularidade, vantagem indiscutível do programa, permite incorporar alongas e extensões às composições, que proporcionam à Mahia soluções alternativas em função das necessidades reais de cada um.

La modularidad, ventaja indiscutible del programa, permite incorporar alas y extensiones a las composiciones, que proporcionan a Mahia soluciones alternativas en función de las necesidades concretas.

La modularité, avantage indiscutable du programme, permet d'intégrer des ailes et des extensions aux compositions, qui offrent à Mahia des solutions alternatives en fonction des besoins concrets.

Modularity, undeniably one of the core features of the programme, means that wings and extensions can be added to the designs, that provide Mahia with alternative solutions according to the specific needs.



# Bench

**Bancada**

Um programa que permite criar multiplicidade de postos em menos espaço. Uma nova forma de entender o trabalho no escritório, fomentando a comunicação entre os trabalhadores e potencializando o trabalho em equipa. Os diversos acessórios disponíveis permitem, além disso, personalizar os postos e manter a privacidade de cada utilizador dentro da sua área.

**Banc**

Un programme qui permet de créer une multitude de postes en moins d'espace. Une nouvelle manière d'entendre le travail au bureau, encourageant la communication entre les employés et favorisant le travail en équipe. Les divers accessoires disponibles permettent, en outre, de personnaliser les postes et de maintenir la privacité de chacun à l'intérieur de son espace de travail.

**Bancada**

Un programa que permite crear multitud de puestos en menos espacio. Una nueva manera de entender el trabajo en la oficina, fomentando la comunicación entre los trabajadores y potenciando la labor en equipo. Los diversos accesorios disponibles permiten, además, personalizar los puestos y mantener la privacidad de cada usuario dentro de su área.

**Bench**

A programme where a multitude of stations to be created in less space. A new way of seeing how people work in the office, by fostering communication between workers and encourage team work. The different accessories available also allow the stations to be customised and ensure the privacy of each user within his area.









## Mahia System.

Mahia cria espaços lineares, abertos à comunicação entre os usuários onde cada posto fica delimitado por blocos integrados ou pés interiores remetidos, como na imagem.

Mahia crée des espaces linéaires, ouverts à la communication entre les utilisateurs où chaque poste de travail se retrouve délimité par des caissons intégrés ou des piétements intérieurs en retrait, comme sur l'image.

Mahia crea espacios lineales abiertos a la comunicación entre los usuarios, donde cada puesto, queda delimitado por bloques integrados o patas interiores retranqueadas, como en la imagen.

Mahia creates linear spaces, to stress communication among the users and where each station is marked out by integrated blocks or setback inside legs, as in the picture.



Mahia System.







As mesas contêm uma caixa central para a gestão dos cabos, com tampas que funcionam por gravidade, dotando a secretária de uma dupla funcionalidade e permitindo utilizar toda sua superfície. Mahia dispõe, também, de separadores em várias cores e acabamentos.

Las mesas disponen de una caja central para la gestión del cableado, con tapas que funcionan por gravedad, dotando a la mesa de una doble funcionalidad y permitiendo utilizar toda su superficie. Mahia dispone, además, de separadores en varios colores y acabados.

Les tables disposent d'une boîte centrale pour la gestion du câblage, avec des couvercles qui fonctionnent par gravité, dotant la table d'une double fonctionnalité et permettant d'en exploiter toute la surface. Mahia dispose, par ailleurs, de séparateurs en différents coloris et finitions.

The tables have a central box to manage the cabling, with covers that work by gravity, which gives the table a double functionality and allows the whole surface area to be used. Mahia also comes with separators in different colours and finishes.

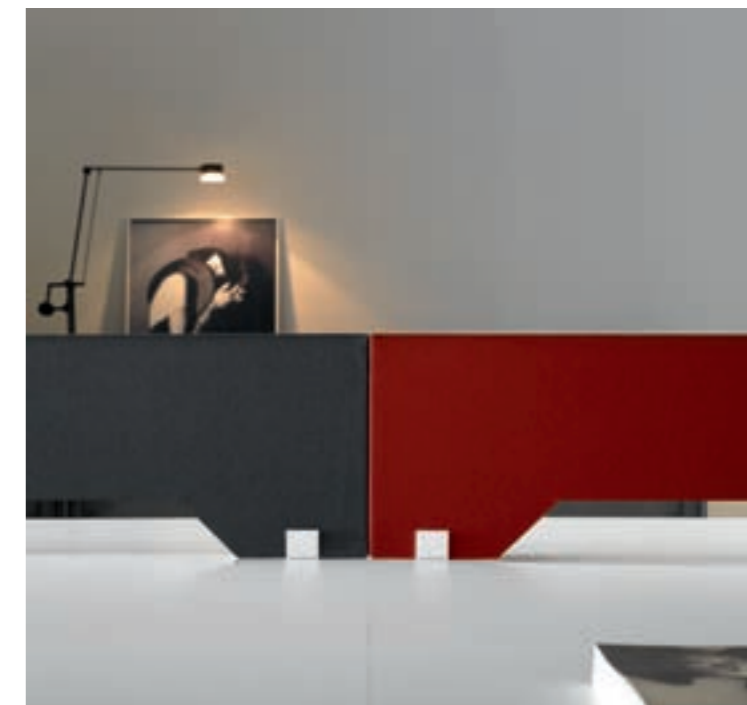

# Technical wall

**Muro técnico**

Um muro técnico que permite a utilização racional do espaço delimitando os postos de trabalho e dotando a instalação de diversas alternativas. O muro pode suportar a mesa, mantendo sempre um espaço vazio debaixo da mesma, proporcionando lugares funcionais repletos de luz que não perdem em privacidade e independência.

**Mur technique**

Un mur technique qui permet l'utilisation rationnelle de l'espace en délimitant les postes de travail et en dotant l'installation de diverses solutions alternatives. Le mur soutient la table, tout en préservant un espace creux sous celle-ci, offrant des lieux fonctionnels baignés de lumière, qui ne perdent rien de leur privacité et de leur indépendance.

**Muro técnico**

Un muro técnico que permite la utilización racional del espacio delimitando los puestos de trabajo y dotando a la instalación de diversas alternativas. El muro sostiene la mesa, manteniendo siempre un espacio hueco bajo la misma, proporcionando lugares funcionales llenos de luz, que no pierden en privacidad e independencia.

**Technical wall**

The technical wall enables the rational use of the space by marking out the work spaces and offering different alternatives for the installation. The wall supports the table, which means that there is always an empty space under it, and creates functional places filled with light, while at the same time ensuring privacy and independence.







# Mahia System.



## Mahia System.

O muro técnico separa mas não isola, une e diferencia. Na imagem, uma área de trabalho atravessada por um muro que facilita a organização e o armazenamento, onde a luz sempre está presente. Igualmente ao resto do programa, o muro técnico pode personalizar-se acrescentando portas, costas e painéis laterais.

Le mur technique sépare mais n'isole pas, il unit et différencie. Sur l'image, un espace de travail traversé par un mur qui facilite l'organisation et le rangement, où la lumière est présente à tout moment. À l'instar du reste du programme, le mur technique peut être personnalisé, avec portes, dos et panneaux latéraux.

El muro técnico separa pero no aísla, une y diferencia. En la imagen, un área de trabajo atravesada por un muro que facilita la organización y el almacenamiento, donde la luz siempre está presente. Al igual que el resto del programa, el muro técnico puede personalizarse con puertas traseras y paneles laterales.

The technical wall separates but does not isolate, links yet differentiates. The photo shows a work area divided by a wall that facilitates organisation and storage, while ensuring a well-lit area. In the same way as the rest of the programme, the technical wall can be personalised with doors, back and lateral panels.



## Mahia System.

Mahia é o um compromisso entre a forma e a função. Um muro que funciona tanto integrado com a secretária como separado, actuando como estante. A peça pode-se personalizar colocando painéis laterais e/ou intermédios de diversos materiais (metálicos, laminados, acrílicos).

Mahia a su conjuguer des lignes franches et fermes avec des volumes aériens. Un mur qui fonctionne aussi bien intégré à la table que séparément, servant d'étagère. La pièce peut se personnaliser appliquant des panneaux latéraux et/ou intermédiaires de divers matériaux (métalliques, laminés et méthacrylates).

Mahia ha sabido conjugar líneas rotundas y firmes con volúmenes que vuelan. Un muro que funciona tanto integrado en la mesa como por separado, actuando de estantería. La pieza se puede personalizar colocando paneles laterales y/o intermedios de diversos materiales (metálicos, laminados, metacrilatos).

Mahia has successful combined strong, lines with volume, yet with no hint of bulkiness. The wall can be used as part of the table or separately as shelving. It can be personalized joining lateral and/or intermediate panels with different materials (metal, laminate, acrylic).



## Mahia System.

Direita, o muro técnico conta com um espaço para a gestão da passagem de cabos e tomadas elétricas, otimizando a funcionalidade da mesa com os diversos periféricos que fazem parte do dia-a-dia do trabalho no escritório.

A droite, le mur technique dispose d'un espace pour la gestion du câblage. Dotant la table d'une finition à la fois plus esthétique et plus élégante.

A la derecha, el muro técnico cuenta con un espacio para la gestión del cableado y enchufes eléctricos optimizando la funcionalidad de la mesa con los diversos periféricos que forman parte del día a día del trabajo en la oficina

On the right, the technical wall has a space to manage the cabling and this gives the table a more aesthetic and elegant finish.



# Meeting

**Reuniões**

Reunir-se significa partilhar ideias e opiniões, trocar impressões e criar em conjunto. Para isso, Mahia desenvolve soluções de formas e conceitos diversos, partindo de distintos materiais e formas específicas atingindo objectos para cada tipo de reunião. E é assim, na diversidade e na união de ideias diferentes, que se baseia o segredo de Mahia.

**Reunions**

se réunir signifie partager idées et opinions, échanger des impressions et créer ensemble. dans cette finalité, mahia développe des solutions aux formes et concepts divers partant de divers matériaux et formes spécifiques, a fin d'atteindre les solutions pour chaque type de reunion. Et c'est là, dans la diversité et dans l'union d'idées différentes, que réside le secret de Mahia.

**Reuniones**

Reunirse significa compartir ideas y opiniones, intercambiar impresiones y crear conjuntamente. Para ello, Mahia desarrolla soluciones a medida utilizando diferentes materiales y formas, consiguiendo así mesas específicas para cada tipo de reunión. Y es ahí, en la diversidad y en la unión de ideas diferentes, donde radica el secreto de Mahia.

**Meeting**

Meeting means sharing ideas and opinions, exchanging impressions and creating together. Therefore, Mahia develops solutions with different materials and specific shapes getting solutions for each type of meeting. And diversity and bringing together different idea is at the roots of the Mahia secret.



## Mahia System.

Os tampos alveolares das mesas de reunião, de acordo com as tendências do design actual, satisfazem as exigências de uma peça forte e robusta, suportando uma vantagem indiscutível relativamente à qualidade: peso reduzido e fácil manuseamento. Na imagem, a mesa de reuniões rectangular em madeira com estrutura recuada.

La finition à âme alvéolaire des tables, dans la ligne des tendances du design actuel, satisfait les exigences d'une pièce épaisse et robuste, apportant un avantage indiscutable quant à qualité : énorme légèreté et maniement aisé. Les panneaux sont disponibles en différentes grosseurs et finitions. Sur l'image, table de réunion à âme de type rectangulaire revêtue de placage bois, piétements en retrait.

El acabado atamborado de las mesas, acorde con las tendencias de diseño actual, satisface las exigencias de una pieza gruesa y robusta, aportando una ventaja indiscutible en cuanto a calidad: enorme ligereza y fácil manejo. Los tableros cuentan con diferentes grosores y acabados. En la imagen, mesa de reuniones rectangular revestida de chapa de madera con patas retranqueadas.

The hollow-flush finish of the tables, in keeping with today's design trends, meets the demands for a strong, well-made article, while providing an undeniable advantage when it comes to quality: it is very light and easy to handle. The table tops come in different thicknesses and finishes. The picture shows a rectangular meeting table, covered with wood veneer and in-set legs.









## Mahia System.

As mesas de reunião Mahia têm vários sistemas construtivos. A forma e o tamanho das mesas, como o resto do programa, personaliza-se para obter um resultado de carácter único.

Les tables de réunion Mahia sont disponibles en divers systèmes constructifs. La forme et la dimension des tables, comme d'ailleurs le reste du programme, sont personnalisées pour offrir un résultat dont le caractère est unique.

Las mesas de reunión Mahia cuentan con varios sistemas constructivos. La forma y el tamaño de las mesas, como el resto del programa, se personaliza para obtener un resultado de carácter único.

The Mahia meeting tables feature different construction systems. The shape and size of the tables, like the rest of the programme, is customised to obtain a unique article.



# Reception

## Recepção

A primeira impressão é a que conta. E conseguir provocar uma sensação aconchegante e formal ao mesmo tempo foi o desafio do balcão de Recepção Mahia. Uma estrutura simples, mas que com a colocação de painéis de diversas medidas e cores, consegue criar uma primeira impressão inesquecível.

## Réception

La première impression est celle qui compte. Et parvenir à donner une sensation tout à la fois accueillante et sérieuse est le défi qu'a voulu relever Mahia Réception. Une structure simple et la mise en place de panneaux en différentes mesures et dans différents coloris, qui parviennent à créer une première impression qui frappe.

## Recepción

La primera impresión es la que cuenta. Y lograr provocar una sensación acogedora y formal al mismo tiempo ha sido el reto de Mahia Recepción. Una estructura sencilla y la colocación de paneles de diversas medidas y colores, que consiguen crear una primera impresión inolvidable.

## Reception

First impressions do count. And the goal for Mahia Recepción was to create a welcoming yet formal atmosphere. A simple structure and the use of panels of different sizes and colours achieves an unforgettable first impression.



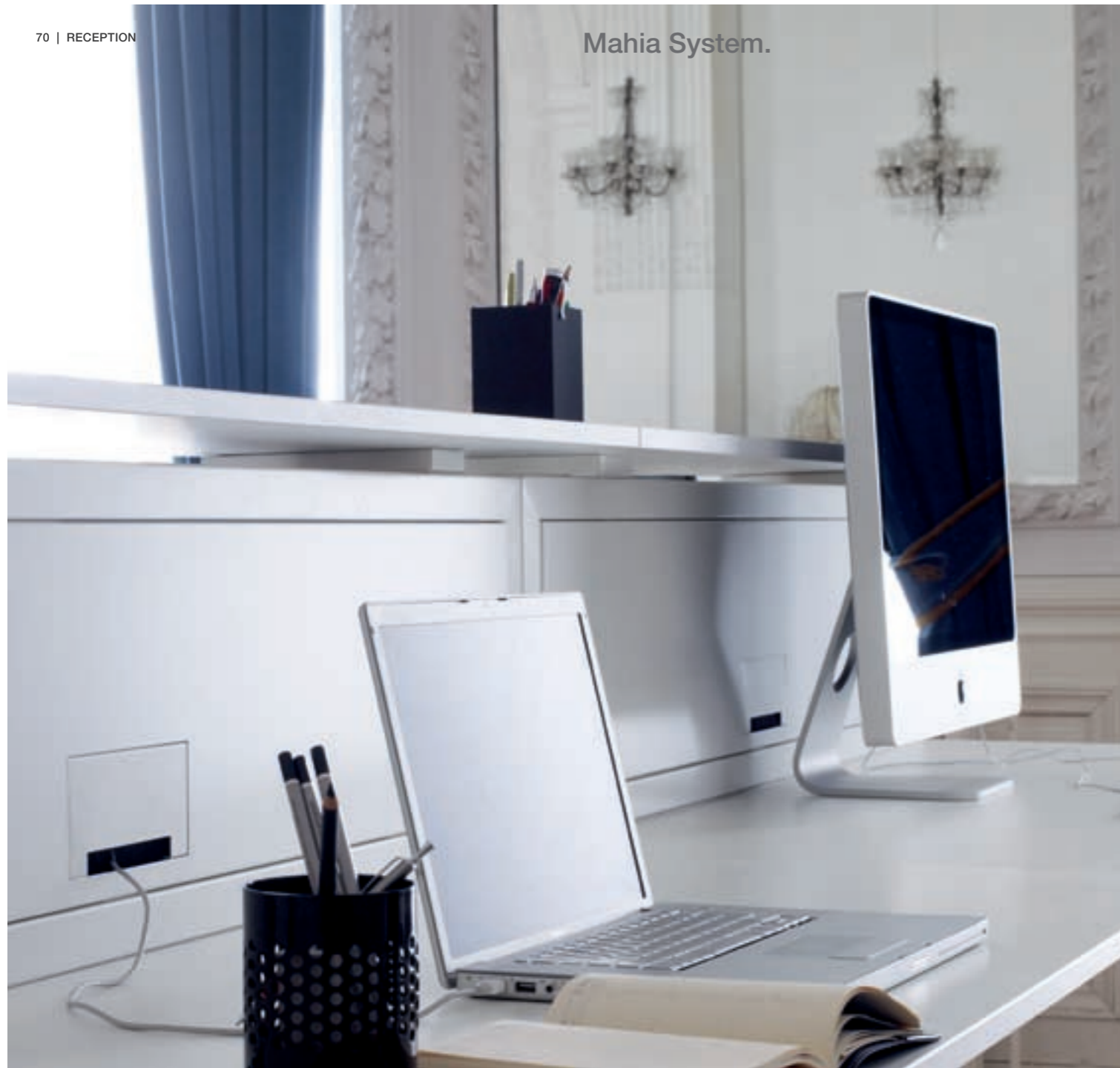

As Diferentes formas e cores que podem ter estas recepções permitem uma personalização bastante completa. O posto conta com passagem de cabos pelo interior da estrutura, deixando assim a superfície da secretária livre de cabos e ao mesmo tempo facilitando a ligação dos equipamentos de trabalho.

Différentes possibilités quant à formes et personnalisation en coloris. Le poste dispose d'un chemin de câbles qui facilite la connexion des équipements de travail tout en éliminant les câbles de la surface de la table.

Diferentes posibilidades en cuanto a formas y personalización en colores. El puesto cuenta con un pasaje de cables que facilita la conexión de los equipos de trabajo y que, al mismo tiempo, deja la superficie de la mesa libre de cables.

A range of shapes and colour options. The workstation has a cable runner that makes it easy to connect the different equipment and also means that the table top is not cluttered up with cables.

## Mahia System.

Os módulos curvos, com ângulos de 45° e 60°, aportam a versatilidade necessária que a construção deste tipo de conjuntos requer.

Les modules courbes, présentant des arcs entre 45° et 60° degrés et disponibles en différents coloris, apportent la touche versatile que requiert la construction de ce type d'ensembles.

Los módulos curvos, con arcos de entre 45° y 60° grados y disponibles en varios colores, aportan la versatilidad necesaria que requiere la construcción de este tipo de conjuntos.

The curved models, with arches of between 45° and 60° degrees and available in various colours, provide the necessary versatility to build these type of units.



# Management

**Direcção**

Singularidade num produto em que os laminados partilham protagonismo com as madeiras, onde as dimensões da secretária aumentam e a estrutura metálica junta-se ao tampo, resultando numa combinação de materiais apelativa.

**Direction**

Singularité d'un produit dans lequel les laminés côtoient les bois, où les dimensions table augmentent et la structure métallique s'assemble au plateau. Le résultat sera une combinaison de matériaux appellation.

**Dirección**

Singularidad en un producto en el que los laminados comparten protagonismo con las maderas, donde las dimensiones de la mesa aumentan y la estructura metálica se une a la encimera, dando como resultado una combinación de materiales sugerente.

**Management**

This is a particularly eye-catching product, featuring laminates and woods. The desk is longer and wider and the metallic structure joints the top. The result is an appealing materials mix.





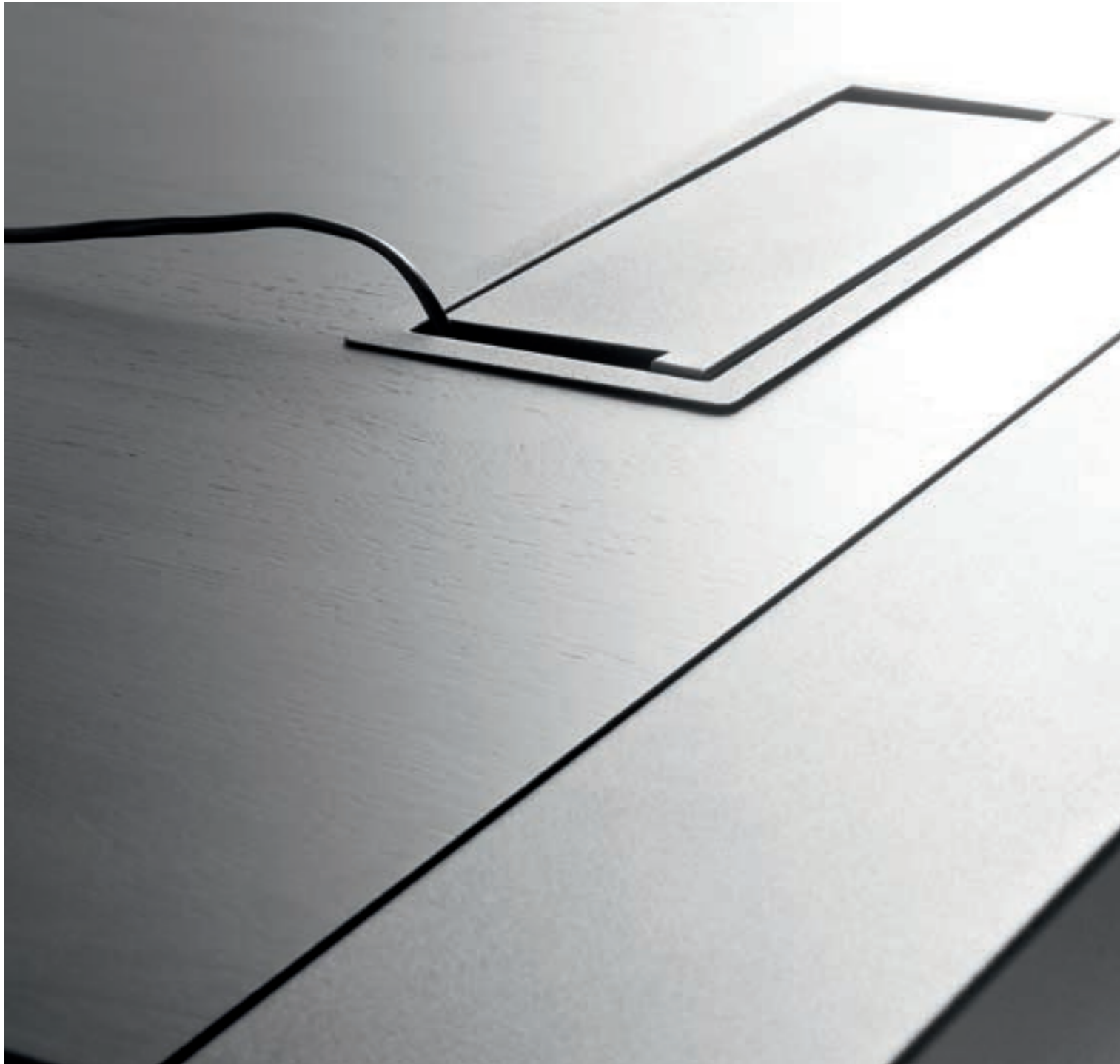

# Mahia System.



# Mahia System.



# Cupboards

## Armários

Os armários estão criados segundo um aspecto construtivo fundamental: um perímetro frontal e posterior igual e com um desenho apurado, que permite utilizar as peças tanto como elementos de armazenamento, bem como de elementos para a organização dos espaços. Um aspecto que atribui aos armários e blocos Mahia o carácter único para o que foram concebidos.

## Armoires

Armoires et caissons créés en prenant en compte un aspect constructif fondamental : un périmètre avant et arrière qui permet d'utiliser les pièces tant comme des éléments d'organisation et de rangement, que comme des éléments structurels pour installations. Un aspect qui procure aux caissons Mahia le caractère personnel pour lequel ils ont été conçus.

## Armarios

Armarios y bloques creados bajo un aspecto constructivo fundamental: un perímetro frontal y posterior que permite utilizar las piezas tanto como elementos de organización y almacenaje, como de elementos estructurales para instalaciones. Un aspecto que aporta a Mahia Contenedores el carácter personal para el que fueron concebidos.

## Cupboards

Cupboards and units designed based on one fundamental construction concept: a front and back perimeter that allows the items to be used as organisation and storage elements or as structural parts of the installation. This ensure that the Mahia containers have the personal touch for which they were designed.

# Mahia System



## Mahia System.

Detalhes construtivos apurados tornam o produto único, como os puxadores embutidos na própria porta que fazem parte integrante dos armários, atribuindo-lhe uma forma depurada e elegante.

Détails de construction soignés qui rendent le produit unique, comme les poignées intérieures qui, intégrées à la porte, dotent le produit d'une sensation de propreté, de singularité et d'élégance.

Mimados detalles constructivos que hacen único al producto, como los tiradores internos que, integrados en la propia puerta, dotan al producto de una sensación de limpieza, singularidad y elegancia.

Careful construction details that make the product unique, such as the internal handles built-into the door that provide a sensation of clean lines, unusualness and elegance.



## Mahia System.

Tanto os armários como os blocos dispõem de diferentes acabamentos para a estrutura, podendo as frentes e as costas ser de outro material. Tudo com o único objetivo: personalizar ao máximo o espaço de que se dispõe.

Autant les armoires que les caissons sont disponibles en différentes finitions. Les façades et portes peuvent être fabriquées avec d'autre matériel. Tout à seule fin de personnaliser au maximum l'espace dont on dispose.

Tanto los armarios como los bloques disponen de diferentes acabados. Frentes y puertas pueden ser de otro material. Todo con el único fin de personalizar al máximo el espacio del que se dispone.

The cupboards and unit come in different finishes. Fronts and doors can be manufactured in a different material. This is to ensure that you can personalise the space available to the maximum.



## Mahia System.

A construção do armário permite dotá-lo de uma dupla funcionalidade, conseguindo organizar através de corredores diferentes espaços de um ambiente de trabalho. A colocação de tela acústica nas costas dos armários garante um melhor isolamento dos espaços com eles divididos.

La construction de l'armoire permet de la doter d'une double fonctionnalité. On parvient de la sorte à structurer à travers des couloirs les différents espaces d'une installation. Acoustical tissues on the cupboards back guarantee a better noise isolation in an installation.

La construcción del armario permite dotarles de una doble funcionalidad, consiguiendo estructurar a través de pasillos los diferentes espacios de una instalación. La colocación de tela acústica en la trasera de los armarios garantiza un mejor aislamiento de los espacios que dividen.

The cupboard is constructed in such a way to ensure it has a double function and can be used to create passageways to structure the different spaces in an installation. L'application d'un tissu acoustique garantie un meilleur isolement des espaces qu'ils divisent.





# Technical Data

A singularidade do programa Mahia radica na combinação da sua simplicidade construtiva com elementos claramente diferenciadores, como a estrutura com forma de cunha. Mahia serve-se do design e da qualidade com o objectivo de solucionar as necessidades de trabalho diárias. Assim, a estrutura básica de onde parte, conta com uma coluna que permite a condução de cabos no seu interior. Um programa totalmente personalizável, repleto de formas e acabamentos variados, desenhado por Aitor García de Vicuña.

La singularité du programme Mahia tient à la combinaison de sa simplicité de construction avec des éléments nettement différenciateurs, tels la structure en forme de coin. Mahia apporte des touches de design et de qualité dans le souci d'offrir des solutions aux besoins de travail quotidiens. Ainsi, la structure de base dont il part compte un piétement pourvu de creux inférieur et supérieur pour permettre le passage du câblage. Un programme entièrement personnalisable quant à formes et finitions, signé Aitor García de Vicuña.

La singularidad del programa Mahia radica en la combinación de su sencillez constructiva con elementos claramente diferenciadores, como la estructura en forma de cuña. Mahia aporta toques de diseño y calidad con el fin de solucionar las necesidades de trabajo diarias. Así, la estructura básica de la que parte, cuenta con una columna. Un programa totalmente personalizable en cuanto a formas y acabados diseñado por Aitor García de Vicuña.

The uniqueness of the Mahia programme is how it combines the ease with which it can be put together with elements that clearly stand out, such as the structure in the form of a wedge. Mahia adds design and quality in order to solve the needs of the everyday work place. Therefore, the basic structure has a hollow leg through which you can run the cable. A programme designed by Aitor García de Vicuña, where the shapes and finishes can be totally personalised.

**OPERATIVE**

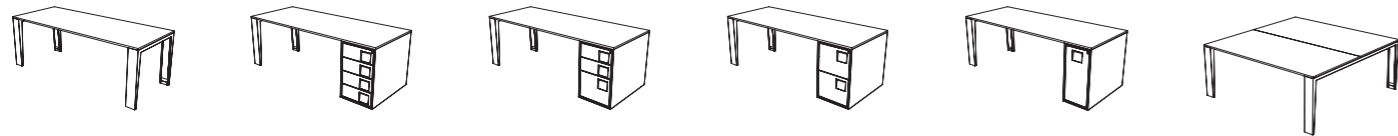

1200x800  
1400x800  
1600x800  
1800x800  
2000x800  
h:720

1400x800  
1600x800  
1800x800  
2000x800  
h:720

1400x800  
1600x800  
1800x800  
2000x800  
h:720

1400x800  
1600x800  
1800x800  
2000x800  
h:720

1200x800  
1400x800  
1600x800  
1800x800  
2000x800  
h:720

1200x1600  
1400x1600  
1600x1600  
1800x1600  
2000x1600  
h:720



800x600  
1000x600  
1200x600  
h:720

800x600  
1000x600  
1200x600  
h:720

800x600  
1000x600  
1200x600  
h:720

800x600  
1000x600  
1200x600  
h:720

800x1200  
1000x1200  
1200x1200  
h:720

**BOXES**



600x435  
h:605

600x435  
h:605

600x800  
h:665

**PANEL**



840x19  
1040x19  
1240x19  
1440x19  
1640x19  
h:300

**CABLE MANAGEMENT**

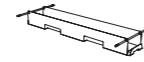

840x150  
1140x150  
1440x150  
h:100

**MANAGEMENT**

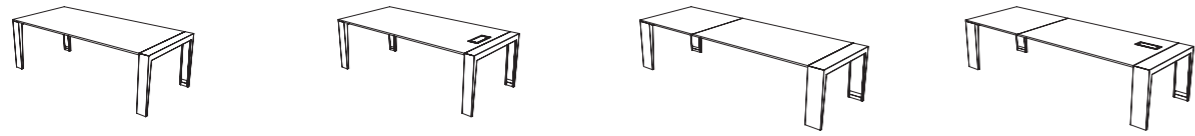

2000x800  
2200x800  
2200x1000  
2400x1000  
h:720

2000x800  
2200x800  
2200x1000  
2400x1000  
h:720

2600x1000  
3000x1000  
h:720

2600x1000  
3000x1000  
h:720

**BOXES**



600x435  
h:605

600x435  
h:605

**SIDEBBOARD**



1200x600  
1600x600  
2000x600  
h:595

1200x600  
1600x600  
2000x600  
h:665

**PANELS**

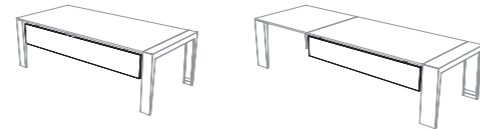

1640x19  
1840x19  
2040x19  
h:300

1640x19  
1240x19  
h:300

**MEETING**

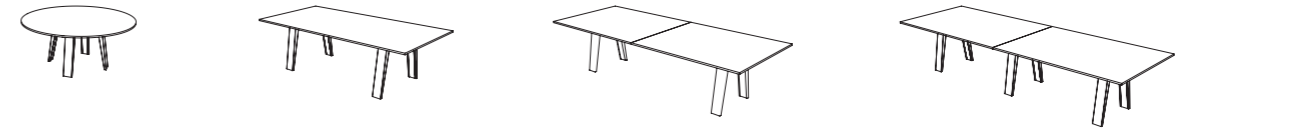

1400  
1600  
h:720

2400x1200  
h:720

3000x1200  
h:720

3600x1200  
h:720



1400x1400  
h:720

2800x1400  
h:720

3200x1600  
h:720

4800x1600  
h:720

**BENCH**

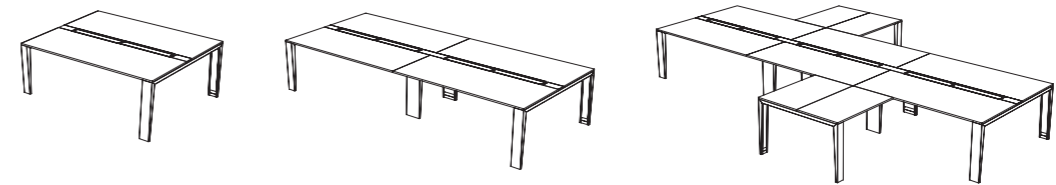

1200x1600  
1400x1600  
1600x1600  
1800x1600  
2000x1600  
h:720

2400x1600 /  
2800x1600  
3200x1600  
3600x1600  
4000x1600  
h:720

3600x1600 + (800/1000/1200)  
4200x1600 + (800/1000/1200)  
4800x1600 + (800/1000/1200)  
5400x1600 + (800/1000/1200)  
6000x1600 + (800/1000/1200)  
h:720

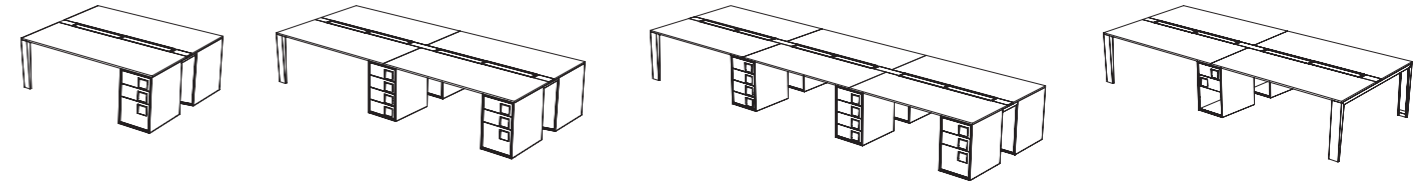

1600x1600  
1800x1600  
2000x1600  
h:720

3200x1600  
3600x1600  
4000x1600  
h:720

4800x1600  
5400x1600  
6000x1600  
h:720

2800x1600  
3200x1600  
3600x1600  
4000x1600  
h:720

**BENCH ACCESSORIES**



1000x300  
1200x300  
1400x300  
1600x300  
1800x300  
2000x300  
h:350

1000x120  
1200x120  
1400x120  
1600x120  
1800x120  
2000x120  
h:350

1000x120  
1200x120  
1400x120  
1600x120  
1800x120  
2000x120  
h:350

1000x120  
1200x120  
1400x120  
1600x120  
1800x120  
2000x120  
h:350

1000x120  
1200x120  
1400x120  
1600x120  
1800x120  
2000x120  
h:350

195x120  
390x120  
780x120

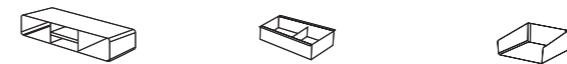

780x300  
h:200

195x130  
h:100

390x127  
h:125

TECHNICAL WALL

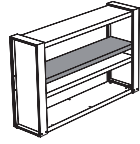

1840x450  
h:1090

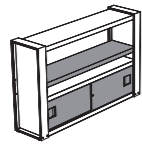

1840x450  
h:1090

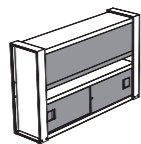

1840x450  
h:1090

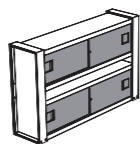

1840x450  
h:1090

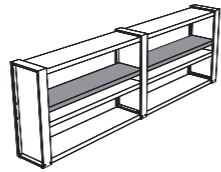

3560x450  
h:1090

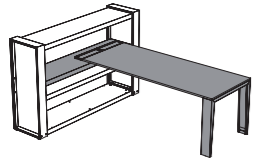

1840x2225  
h:1090

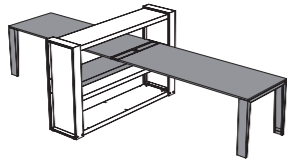

1840x4000  
h:1090

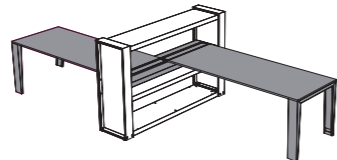

1840x4000  
h:1090

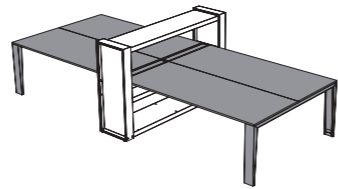

1840x4000  
h:1090

RECEPTION

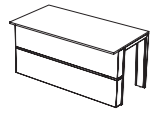

1400x830  
1600x830  
1800x830  
h:720

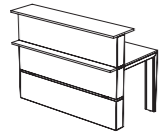

1400x830  
1600x830  
1800x830  
h:1090

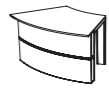

45°  
1300x1120  
h:720



45°  
1300x1120  
h:1090

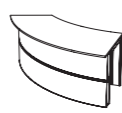

60°  
1580x1330  
h:720

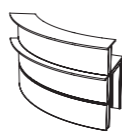

60°  
1580x1330  
h:1090

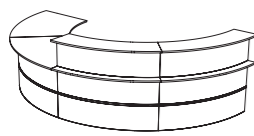

3660x1830  
h:1090

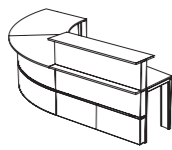

3230x1830  
h:1090

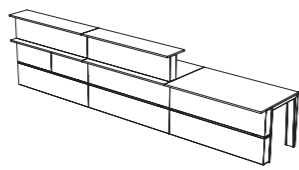

4200x830  
h:1090

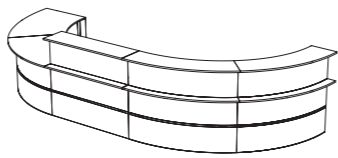

5060x1830  
h:1090

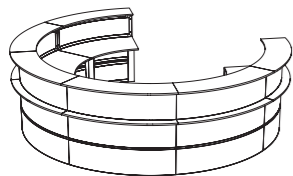

3660x3120  
h:1090

CUPBOARDS



800X450  
1000X450  
1200x450  
h:1980



800X450  
1000X450  
1200x450  
h:1615



800X450  
1000X450  
1200x450  
h:1435



800X450  
1000X450  
1200x450  
h:1055



800X450  
1000X450  
1200x450  
h:765



800X450  
h:1980



800X450  
h:1615

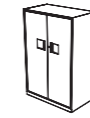

800X450  
h:1435



800X450  
h:1055



800X450  
h:765



800X450  
1000X450  
1200x450  
h:1980



800X450  
1000X450  
1200x450  
h:1615



800X450  
1000X450  
1200x450  
h:1435

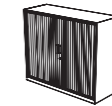

800X450  
1000X450  
1200x450  
h:1055



800X450  
1000X450  
1200x450  
h:765



800X450  
1000X450  
1200x450  
h:1980



800X450  
1000X450  
1200x450  
h:1615



800X450  
1000X450  
1200x450  
h:1435

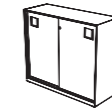

800X450  
1000X450  
1200x450  
h:1055

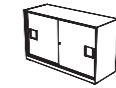

800X450  
1000X450  
1200x450  
h:765

## CONDUÇÃO DE CABOS | CABLEADO | PASSAGE DE CÂBLES | CABLE MANAGEMENT

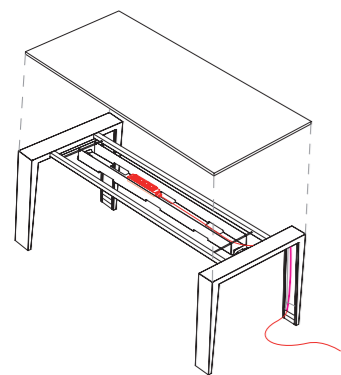

As colunas das secretárias Mahia permitem a condução de cabos, através de uma tampa extraível, facilitando a electrificação das mesmas de forma discreta. A electrificação está prevista em todos os postos de trabalho, nomeadamente nas bancadas e no muro técnico.

Les piétements des bureaux Mahia permettent les passages de câbles, à travers d'un top extractible, facilitant l'électrification d'une façon discrète. L'électrification est prévue sur tous les postes de travail, pour les bench et le mur technique.

Las columnas de las mesas Mahia permiten la conducción de cableado de manera discreta mediante una tapa extraíble. La electrificación está prevista en todos los puestos de trabajo, incluyendo bancadas y muro técnico.

Mahia provides an easy access for the subtle integration of electrical power via the leg through a removable cover. Cable management is thought for all type of workstations, bench and technical wall included.

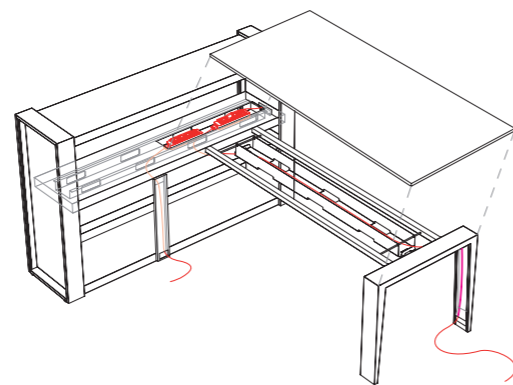
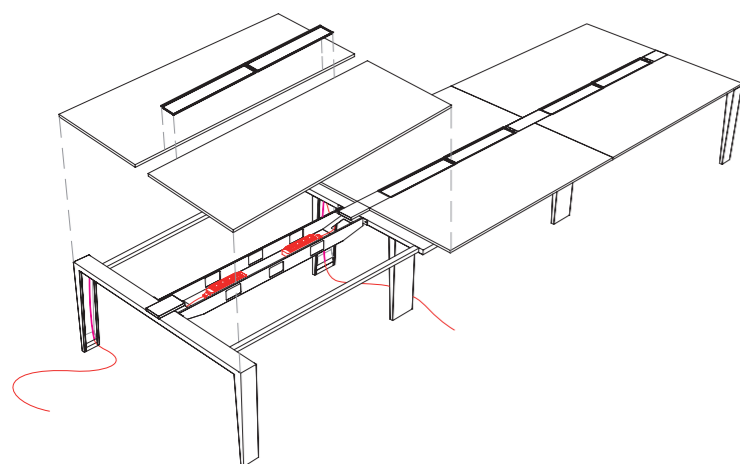

## REGULAÇÃO EM ALTURA | PATA REGULABLE | RÉGULATION EN HAUTEUR | HEIGHT-ADJUSTABLE LEG

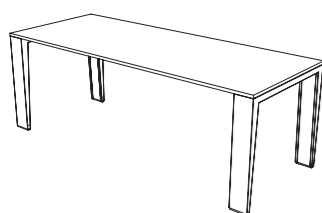
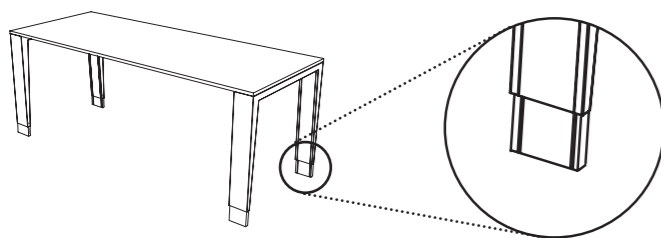

Mahia disponibiliza também a opção de secretária regulável em altura, abrangendo assim necessidades mais específicas de alguns postos de trabalho. O intervalo de regulação permitido é entre 680 e 820mm e pode ser ajustado manualmente.

Mahia permet aussi l'option de régulation en hauteur, abrégant aussi les besoins plus spécifiques de certains postes de travail. L'espace de régulation permis est entre 680 et 820 et peut être ajusté manuellement.

Mahia dispone de opción de mesa regulable en altura, cubriendo de esta forma las necesidades más específicas en algunos puestos de trabajo. El intervalo de regulación esta situado entre 680mm y 820mm y puede ser ajustado manualmente.

Mahia legs have the option of being height adjustable and have a range of 680 to 820mm to respond to the various need of the client. It can be adapted very easily.

## ESTRUTURAS | ESTRUCTURAS | STRUCTURES | STRUCTURES

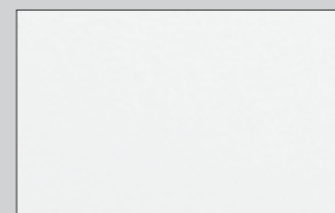

REF: 39. Branco / Blanco / Blanc / White

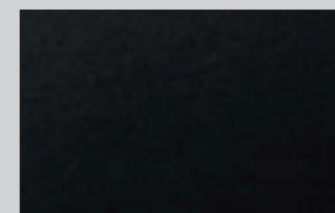

REF: 18. Preto / Negro / Noir / Black

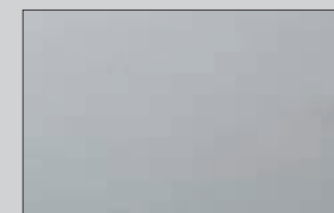

REF: 23. Alumínio / Aluminio / Aluminium / Aluminium

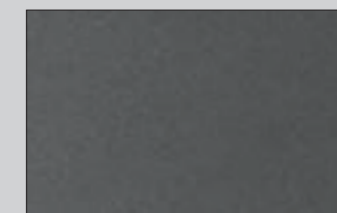

REF: 149. Antracite texturado / Antracita texturizado / Anthracite texturisé / Anthracite textured

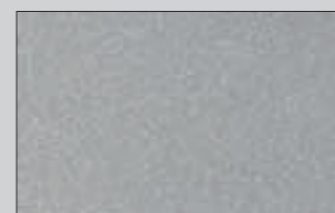

REF: 148. Alumínio texturado / Aluminio texturizado / Aluminium texturisé / Textured aluminium

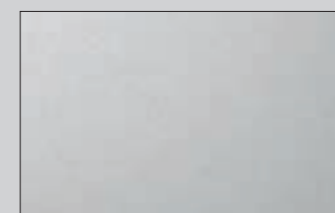

REF: 48. Cinzento texturado / Gris texturado / Gris texturisé / Textured grey

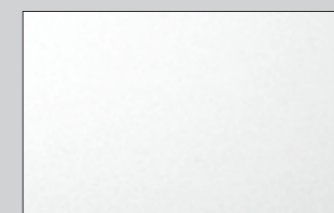

REF: 239. Branco texturado / Blanco texturizado / Blanc texturisé / Textured white



REF: 16. Preto texturado / Negro texturizado / Noir texturisé / Textured black

## LAMINADO | LAMINADO | LAMINÉ | LAMINATE

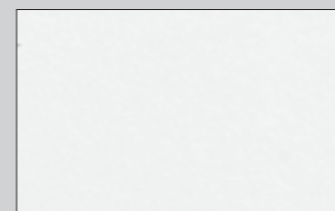

REF: 369. Branco / Blanco / Blanc / White

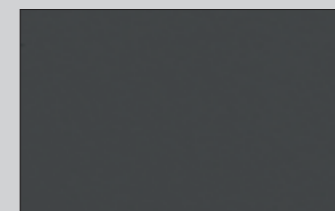

REF: 280. Cinzento-escuro / Gris oscuro / Gris foncé / Dark grey



REF: 279. Maple / Maple / Maple / Erable

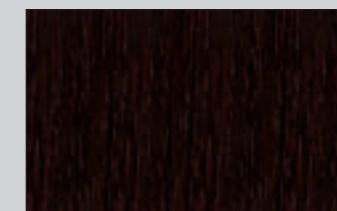

REF: 273. Wengué / Wengue / Wenge / Wenge

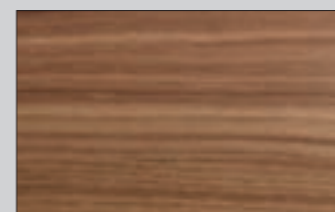

REF: 368. Cerejeira / Cerezo / Cherrywood / Merisier

## MADEIRA | MADERA | BOIS | WOOD

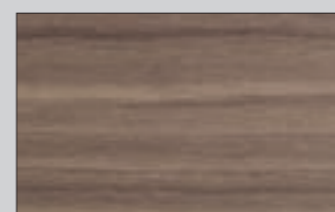

REF: 166. Nogueira clara / Nogal claro / Noyer clair / Light walnut

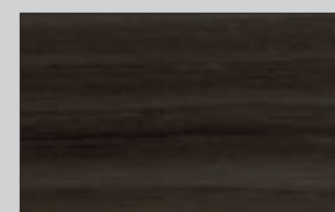

REF: 167. Nogueira escura / Nogal oscuro / Noyer foncé / Dark walnut



## Aitor García de Vicuña

Vitoria-Gasteiz, 1970. Estuda design industrial na Escola de Desenho de San Sebastián y na Escola Experimental de Desenho de Madrid. Simultaneamente participa em projectos de interiores. Trabalha vários anos em diversos gabinetes de engenharia de produtos, espanhóis e internacionais. Incorpora-se como sócio e coordenador do departamento de desenho industrial, em Spiral Comunicación. No ano 2003 constitui AGVestudio, desenvolvendo projectos integrais de desenho industrial, centrados no mundo do habitat, espaços de trabalho e mobiliário urbano. Desde esse momento tem colaborado com vários projectos para conhecidas empresas do sector.

Vitoria, 1970. Estudia diplomatura en diseño industrial en la Escuela de Diseño de San Sebastián y en la Escuela Experimental de Diseño de Madrid. Simultáneamente participa en proyectos de interiorismo. Trabaja varios años en diversos estudios de ingeniería de producto nacionales e internacionales. Se incorpora como socio y coordinador del departamento de diseño industrial, en Spiral Comunicación. En el año 2003 funda AGVestudio, desarrollando proyectos integrales de diseño industrial, centrados en el mundo del hábitat, espacios de trabajo y mobiliario urbano. Desde ese momento ha colaborado en multitud de proyectos para conocidas empresas del sector.

Vitoria (1970). Titulaire d'une licence en design industriel à l'Ecole de Design de Saint-Sébastien et à l'Ecole expérimentale de Design de Madrid. Participe simultanément à des projets de décoration d'intérieur. Travaille plusieurs années dans différents studios d'ingénierie de produit nationaux et internationaux. Entre comme associé et coordinateur du département de design industriel, chez Spiral Comunicación. En 2003 fonde AGVestudio. Développe à cette occasion des projets intégraux de design industriel, axés sur le monde de l'habitat, des espaces de travail et du mobilier urbain. A collaboré depuis lors à une multitude de projets pour des entreprises connues du secteur.

Vitoria, 1970. He studied Industrial Design at the San Sebastián School of Design and at the Madrid Experiment Design School. He was involved in different interior design projects at the same time. He was part of different international and national product engineering studies for several years. He joined Spiral Communication as a partner and was the coordinator of the Industrial Design Department. In 2003, he founded AGVstudio, which specialises industrial design integral projects, focused on the living area, work spaces and urban furniture. Since then, he has worked on a range of projects for well-known companies in the sector.





**FAMO:**  
WORKING  
TOGETHER

**INDÚSTRIA DE MOBILIÁRIO DE ESCRITÓRIO, LDA.**  
RUA 1º DE MAIO, Nº 112 4620-131 LOUSADA PORTUGAL  
T + 351 255 810 580 F + 351 255 810 589  
LOUSADA@FAMO.PT WWW.FAMO.PT

01 - 09/2009